

Our
collection.

LivingFlame

LIVINGFLAME.CO.NZ



Beautiful fires for beautiful homes

Beautiful fires
for beautiful
homes.

LivingFlame

LIVINGFLAME.CO.NZ

+64 9 622 1148

INFO@LIVINGFLAME.CO.NZ

343B CHURCH STREET, PENROSE, AUCKLAND



6. Thermoflow Design
7. Thermoflow Convector
10. Thermoflow Original Black
11. Thermoflow Intense
12. Thermoflow Excite
13. Thermoflow Allure
14. Eastside Designer Fireplaces
18. Eastside Vision Fireplaces
19. Eastside Manhattan Fireplaces
20. Custom Made Baskets & Inserts
21. Custom Made Commercial
22. Chef Entertainer
24. Pit Fire wood cook on or Gas
25. Brasiers and Flares
26. Aura Entertainer
27. Power Flue
28. Easy Design Service

Welcome



To what we hope will be an invaluable guide to enhancing your individual lifestyle with the warmth of a Living Flame gas fireplace. Whether you're renovating your home or building a new home, we can assist you with choosing the best fireplace to suit your needs. Our consultants understand the process of selecting the right fireplace to meet your highest expectations and make your fireplace the heart of your home.

A Living Flame fireplace is more than just a gas fire. It represents our company's commitment to you, offering unrivalled experience and technical expertise supported by lifetime guarantees. We offer superior products that are world class from concept and design to manufacture. Whether you require a classic look or prefer a more contemporary design, we can offer you a fire to suit your needs.

We invite you to look at the design features in the following pages that set Living Flame fireplaces apart and see the benefits they bring you. We also have dedicated technical staff who can guide you through your project and are available to give you, your architect, builder, gasfitter, electrician or finisher advice throughout the entire installation of your fireplace.



Passion Fire a passion

All my life since I was a small boy, I have been fascinated by fire. The way it feels, the colours, the light, the flames, the glow, the heat - never happier than when sitting or playing in front of an open fire.

A passion that I like to share with customers, friends and those who work around me. A passion for designing gas fires that not only look like a fire, gas fires that feel like a fire, all designed with special features that give unique benefits.

This has led to my desire to design and build fires for Living Flame that I would like in my home and that would more than fulfill the needs of others. A passion to provide the highest quality fires available through many years of experience, research and development.

Providing leading edge technology, manufacture and design skills that are unsurpassed in New Zealand.

Our small, friendly team are here to help and are proud to bring our customers the largest range of quality New Zealand designed and manufactured gas fires. Fires with unrivalled features and benefits such as our unique full flame effect with glowing embers, greater heat and lower running costs, to name but a few.

We believe so passionately that our fires are the best, that we will assist our customers in any way to ensure that every Living Flame fire is installed correctly, so that all the real benefits of Living Flame fires can be enjoyed.

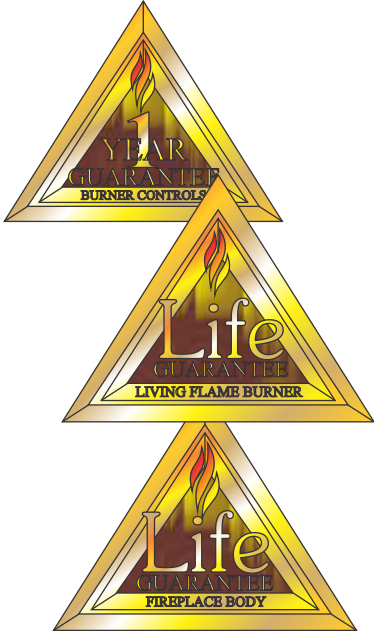

Thermoflow Convector

Living Flame doesn't follow others. We design and have been designing gas fires and fireplaces since 1982, supplying over 30,000 customers needs and creating stunning new gas fires and fireplaces that lead the world in concept and design.

Building fires that are made to have a durable life and give years of practical pleasure.

Design Criteria

Living Flame Gas Fires should not only look like a fire, they should feel like a fire.

Additional Criteria

Maximum heat for less gas. Extended heat surface with air convection sides and spaces for greater convection and efficiency.

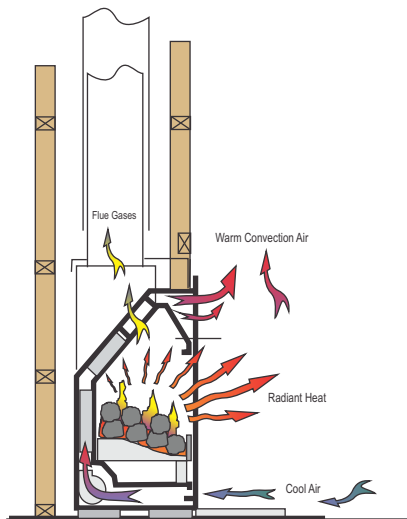

Easily installed into timber framing or masonry construction.

Built in safety clearances.

Practical, safe, easy to use and reliable control systems.

Ease of maintenance.

Design features which enhance the gas fireplaces and make the difference such as:

The Diffuser Burner for the evenly distributed gas flames, creating the best looking fires.

Practical features like control covers that won't come off in your hand and scratch the fireplace or hearth.

Living Flame is New Zealand’s original designer of convectional gas fireplaces, offering the advanced features of the latest designed convector gas fireplaces.

The Living Flame Thermoflow design dual heating system delivers high levels of radiant heat with warm convected air. Cool air is drawn in at the base of the fire and passes over the multi-finned convector.

The Thermoflow has specially designed backs and sides to slow the air in the convector and allow it to gain as much heat as possible before traveling back into the room. Additional heat which would otherwise be lost to the chimney or absorbed into the cavity is returned to the room

without the need for additional insulation or the extra cost of insulation kits.

Products of combustion are minimised and discharged through specially designed V ports in the convector which are designed to restrict heat loss as products of combustion are removed.

This dual heating system combined with Living Flames' advanced gas fire technology and control systems, make Living Flame Fireplaces the most effective and realistic open gas convector fireplaces available on Natural Gas or LPG bottle gas.

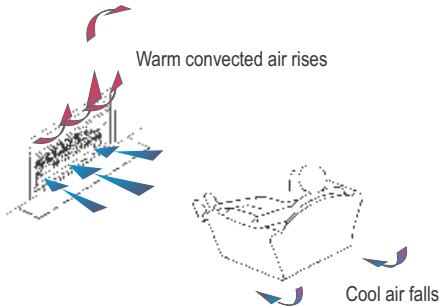
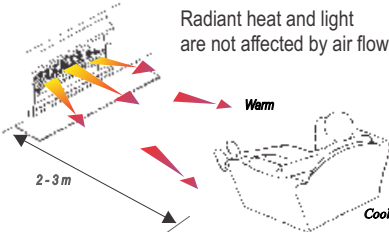

Thermoflow Radiant and Convector Fireplace



Exceptional quality Thermoflow Fireplaces bring warmth and ambience to any room, creating a welcoming focal point when the weather is cooler.

Thermoflow Gas Fireplaces encompass an extensive range and are available in sizes from 450 mm wide to a huge 1500 mm wide and can be stylised individually to suit an ultra modern home in stainless steel or with stainless steel detailing for clear and concise lines.

Thermoflows can be manufactured to suit an existing fireplace or can be easily installed into timber framing.

Thermoflow Fireplaces give you the magnificence of a roaring open fire and the convenience of controlling the heat with manual variable controls or electronic options.

Ash, dust, hard work and the dangers of a conventional fire all become things of the past.



The Thermoflow's dual heating system gives you an effective way to heat yourself and your home, giving radiant heat that warms you like the sun and convected heat which warms the air around you. The special diffuser flame effect burner glows all over, maximising the radiant heat given, with an all over flame.

Further details and specifications are available in our installation guidelines.

- Fire Sure Lifetime Body Guarantee.
- Fire Sure Lifetime Burner Assembly Guarantee.
- One Year Control Assembly Cover.
- One Year Labour Cover.
- Proudly New Zealand made

Superbly designed fireplaces that can be dressed as individually as yourself.

Unique diffuser burner which gives you all over flames with glowing embers.

A convector extended heat surface gives you greater warmth.

Built in safety clearances so that it is easily installed in a timber frame.

Existing masonry chimneys can be utilised.

Fan forced convection air system.

Thermoflow wiring to upgrade to electronic controls if required in the future.

Electronic control options for lighting at the flick of a switch.

Monitored flame safety controls.

Thermoflow trim, grate and effect options.

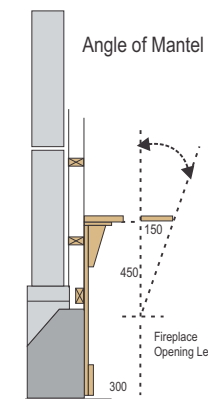

Thermoflow

Original Black 450 - 1500 x 50 steps



Thermoflow Black the original gas convector fireplace full of the latest advances in gas fireplace design technology, which complement today's lifestyle and homes .

Heating & Running Cost

- ✓ Convection Efficiency Maximise Technology
- ✓ MHRB High Efficiency Radiant Burners (Maximum heat using the least amount of gas)
- ✓ Coal, Log & Ember Effect High Glow Elements
- ✓ Log & Ember Effect High Glow Elements
- ✓ Coal & Ember Effect High Glow Elements

Control Systems

- ✓ Manual
- ✓ Electronic - Auto Spark - Hi Low flame
- ✓ Remote Control
 - 6 multi step mode (manual step up & down as you desire)
 - Smart mode (Auto step up and down to set point.)
 - Temp mode (Auto turns On & Off to set point.)

Convection Fan

- ✓ Choice of grate front, legs and finish

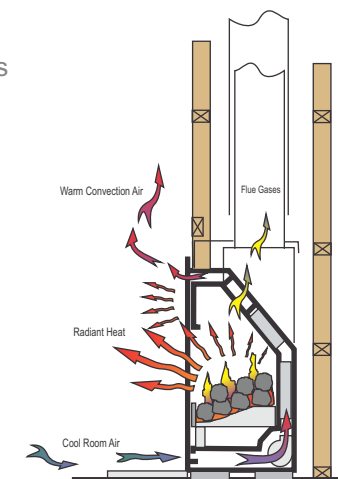

Thermoflow Intense 1000 - 1200 - 1500



Intense a contemporary gas fireplace full of the latest advances in gas fireplace design technology, Sleek minimal lines which complement today's lifestyle and homes - Stainless Steel or Black.

Living Flame NZ leads gas fire and fireplace design with many innovations

Heating & Running Cost

- ✓ Convection Efficiency Maximise Technology
- ✓ MHRB High Efficiency Radiant Burners (Maximum heat using the least amount of gas)
- ✓ Coal, Log & Ember Effect High Glow Elements
- ✓ Log & Ember Effect High Glow Elements

Remote Control System

- ✓ 6 multi step mode (manual step up & down as you desire)
- ✓ Smart mode (Auto step up and down to set point.)
- ✓ Temp mode (Auto turns On & Off to set point.)

Auto Fan Control

- ✓ Turns fan On & Off to preset convector set point

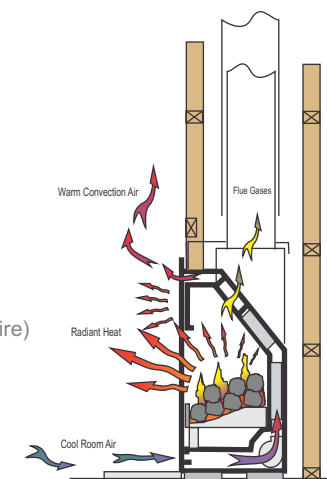

Thermoflow **Excite** 1000 - 1200 - 1500



Excite a contemporary gas fireplace with all the latest advances in design technology of gas fireplaces, minimal lines which complement our lives and homes - Stainless Steel or Black comes complete with cantilevered hearth structure.

Living Flame NZ leads gas fire and fireplace design with many innovations

Heating & Running Cost

- ✓ Convection Efficiency Maximise Technology
- ✓ MHRB High Efficiency Radiant Burners (Maximum heat for less gas)
- ✓ Coal, Log & Ember Effect High Glow Elements
- ✓ Log & Ember Effect High Glow Elements

Remote Control System

- ✓ 6 multi step mode (manual step up & down as you desire)
- ✓ Smart mode (Auto step up and down to set point.)
- ✓ Temp mode (Auto turns On & Off to set point.)

Auto Fan Control

- ✓ Turns fan On & Off to preset convector set point

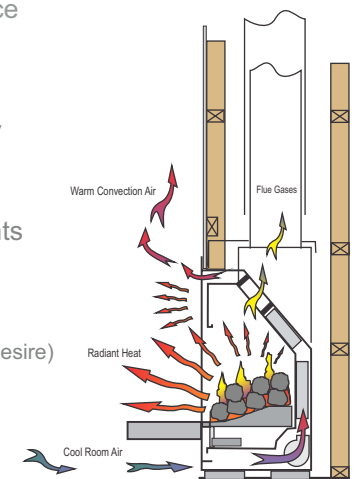

Thermoflow Allure 1200 - 1500



Allure a contemporary Strip Gas Fireplace with all the latest advances in design technology of gas fireplaces, minimal lines which complement our lives and homes.

Living Flame NZ lead gas fire and fireplace design with many innovations.

Heating & Running Cost

- ✓ Convection efficiency maximise technology
- ✓ MH high efficiency strip burner
Compliant and tested to AS 4558 - AG 108 - Type 2
- ✓ Cotswold Stone effect elements in
- ✓ white, gray, black

Remote Control System

- ✓ 6 multi step mode (manual step up & down as you desire)
- ✓ Smart mode (Auto step up and down to set point.)
- ✓ Temp mode (Auto turns On & Off to set point.)

Auto Fan Control

- ✓ Turns fan On & Off to preset convector set point

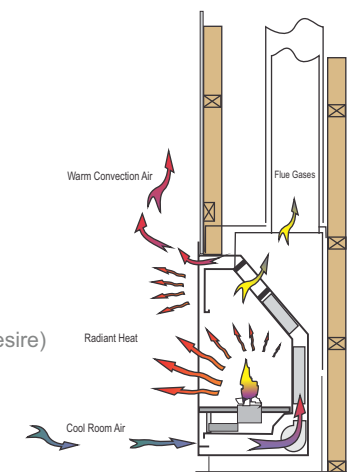

Eastside Designer Fireplace



The Eastside range of fires offer you sleek, contemporary, clean lines and the flexibility to not only enhance but transform your living space.

They are available as a standard model or they can be specially designed to accommodate a recessed plasma screen above or a treasured work of art.

The unique burner range means you achieve the look you require, choosing from the diffuser burner where the entire ember bed glows with warmth or a more contemporary look with the strip burner, a wall of fire the length of the burner.

There are many different ways to dress your fire, from the familiar coal and log look to the new distinctive Cotswold stones and even embers alone, that set your fire apart from the rest. Available in a number of lengths and six different configurations.



Eastside Designer Fireplace

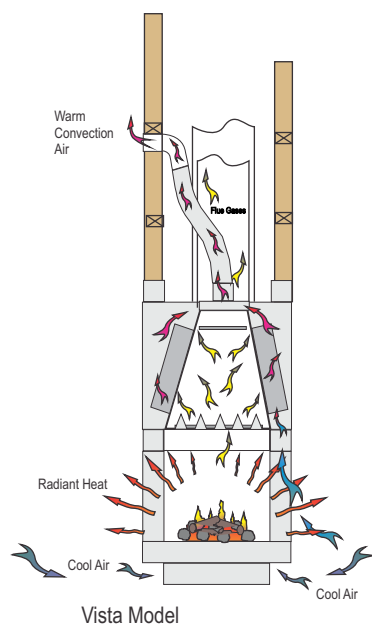

Living Flames' innovative designers have created a range intended for more contemporary homes. This range of ultra modern fires incorporates:

The Eastside long and sleek, with minimalistic clean lines, from 900mm to 3000mm wide and longer. Options include diffuser fire beds with coals, logs and embers or logs and embers. Strip burners with cotswold stones or embers alone.

The Vision Fire will enhance the ambience of the room and create a focal point in your home.

Manhattan, the compact version, will suit apartments and is ideal for a smaller room or where wall space is at a premium.

The Eastside, Vision and Manhattan Fires come in six different configurations - the Niche corner

model, the Quattro free-standing fireplace, the Vista room divider, the Nook that can be viewed from two different rooms, the Euro parallel model and the Nova inbuilt fireplace. The difference between the three being the dimensions, ensuring there is a model to suit every home.

Living Flame fireplaces allow you to make a personal statement and create your own style. They can be finished in many different ways including marble, stone, slate, stainless steel - the choices are endless. They incorporate many advanced features such as full electronic operation, safety flame monitoring controls and multi burner lighting and operation on larger models.

You can complete the fireplace with so many finishes - marble, stone, slate, steel, stainless steel or plain - to complement your individual decor, your choices are endless.

Dual Radiant & Convection Gas Fireplaces

This range of Living Flame designed fireplaces have a dual radiant and convection heating system allowing the flames to heat you, whilst heat which would otherwise be lost up the flue, is trapped in a specially designed convector at the top of the fire. Warm, convected air is then re-directed back into the room through flexi ducting and convector grilles at ceiling level.

Unique

Diffuser fire beds with coals, logs and embers or logs and embers.

Strip burners with cotswold stones or embers alone as an option.

Dual radiant and convection heat.

Electronic control at the flick of a switch gives you

control over the fire, the flame levels and allows multi burner lighting on larger models. Electronic monitored flame safety control - safer than a traditional, uncontrolled open fire.

Installed into existing or new homes, directly onto wooden floors with minimum clearances.

Earthquake safe as they are installed with a stainless steel flue.

Proudly New Zealand made
 Fire Sure Lifetime Body & Burner Guarantee.
 One Year Control Assembly Cover
 One Year Labour Cover

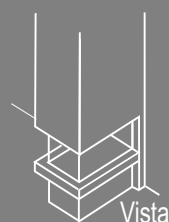

Vista

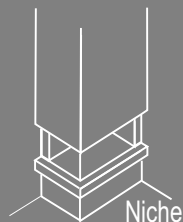

Niche



Nook & Nova

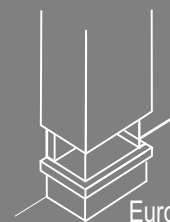

Euro

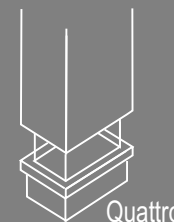

Quattro

Eastside



Eastsides are also fully electronic for flame control at your fingertips. These controls allow for future home automation capability with multi function remote controls or even cell phone dial up. We can work with your Home Automation Specialist to give you the future control you need.

The Eastside fireplace allows you to make a personal statement and create your own style for today. You can finish your fireplace with marble, stone, slate, stainless steel - the choices are endless to complement your decor.

Proudly New Zealand made.
 Diffuser & Strip burners.
 Electronic finger tip control & monitored flame failure.
 Fire Sure Lifetime Body & Burner Guarantee.
 One Year Control Assembly Cover.
 One Year Labour Cover.
 Coals, Logs and Embers.
 Cotswold Stones.
 Embers only.



Eastside Vision Fireplaces



Living Flames' innovative designers have created the Vision medium sized range which enhances the modern room and creates a stunning focal point in your home.



Minimalist clean lines with a footprint of 1100 x 700mm, the fire comes standard with the diffuser fire bed complete with logs and embers. Effect options are logs, coals and embers, Cotswold stones or embers alone. There is also a burner design option of a strip burner that gives you the flexibility to choose the look you prefer for the exceptional home.



The Living Flame Vision range of designer fireplaces are available in six different configurations. The Niche corner model, the Quattro free-standing fireplace, the Vista room divider, the Nook which can be viewed from two different rooms, the Euro parallel model and the

Nova inbuilt fireplace.

Visions allow you to make a personal statement and create your own style, incorporating many advanced features such as full electronic operation, safety flame monitoring where if the pilot is extinguished then the gas automatically turns off, burner lighting and operation.

You can finish your Vision fireplace in so many ways - glass, marble, stone, slate, steel, stainless steel or tiles - to complement your individual decor, your choices are endless.



Eastside Manhattan Fireplaces

Our design team have also created the Manhattan compact sized range to enhance the modern smaller room and home, creating an exceptional focal point especially in an apartment.

Smaller, but still with sleek minimalist lines and a footprint of only 900 x 500mm, the Manhattan has the diffuser fire bed with logs and embers. Options are logs, coals and embers, Cotswold stones or embers alone. There is a burner design option of a Strip burner that gives you the flexibility to choose the look you prefer for your home.

The Manhattan range of designer fireplaces are also available in the six different configurations - the Niche corner model, the Quattro free-standing fireplace, the Vista room divider, the Nook which can be viewed from two different rooms, the Euro

parallel model and the Nova inbuilt fireplace.

Manhattans give you the opportunity to make a style statement with advanced features such as full electronic operation, safety flame monitoring, burner lighting and operation.

Complement the Manhattan fireplace with a large selection of finishes - glass, marble, stone, slate, steel, stainless steel or tiles - to match your individual interior design.

Proudly New Zealand made.

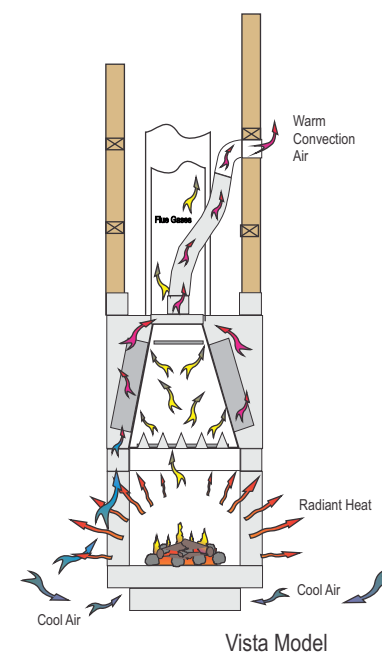

Custom Made Registers, Baskets, Inserts



We design fires for traditional homes and villa fireplaces to maintain the charm and character without the work and risk of conventional wood burning open fires. In older homes no two fireplaces are exactly the same, so we custom make insert burners to fit these existing fireplaces and cast iron register. Alternatively, we also manufacture a traditional Thermoflow 650 Register Convector Fireplace complete with a fan that has a round cast register front which can be easily installed in a timber frame.

Existing masonry chimneys can be utilised.
Earthquake safe with a stainless steel flue.
Monitored flame failure is fitted so that if the pilot goes out, the fire automatically turns off.
Earthquake safe with a stainless steel flue.



Custom Made Contemporary & Commercial



New Zealand commercial premises and home designs tend to be very individual whether new or existing. Living Flame custom design and build gas fires and fireplaces which are as individual as you and your home, the best Bars, Cafes, top Hotels or Restaurants. Living Flame can showcase all the splendour, atmosphere and hospitality of the open fireplace whether modern or traditional whilst maintaining the safety standards and the laws of physics needed for a correctly functioning fireplace.

Unique open gas fireplaces can be created using many choices of materials: brick, stone, marble or stainless steel linings, incorporated into our special pre-fabricated fireplaces and flue systems. We even make replacement type burners for customers with other brands of fireplaces.



Chef Outdoor Cook On Fireplace



The Chef Cook On Fireplace is designed so that you may have the best of both worlds. A barbeque that easily converts to a roaring outdoor gas fire. Extend your evenings entertaining allowing you to enjoy the indoor outdoor lifestyle even when the nights are cooler. Create great indoor outdoor flow with a fireplace that has all the magic of an open fire without the inconvenience and mess of lighting a wood fire.

Diffuser fire bed with coals, logs and embers or logs and embers.

Monitored flame safety control - safer than a traditional uncontrolled open fire.

Installed into existing or new homes, directly onto wooden decks with minimum clearances.

Outdoor Stainless Steel Cook On Fireplaces



They say "necessity is the mother of invention" and so it was with the Chef. There was a real need for a decent sized outdoor cook on fireplace, all stainless steel, good looking, easy to care for and easy to keep clean.

Frustrated by barbecues rusting after a year or so, the messy cleaning, the smell of old fat and all the fiddly parts to clean, we decided that enough was enough. No more parts to clean or soak in the sink and no more having to steam clean once a year.

The Chef is so different. In either a 1200mm or 1500mm width it is superb to cook on, from steak to pikelets, vegetables, eggs to ratatouille and roasts, the generous cook plate copes with it all. Living Flames twin diffuser fires with dual variable controls on the 1200 mm model or the 1500 mm

model, allows you the full versatility to cook up a banquet for friends and guests. On quieter occasions, use just one control and one portion of the cook plate, leaving the other side(s) to keep food warm or warm the plates.

Even with the fattiest of foods, cooking is easy as the fat simply drains away into a special stainless steel drawer, that you can take out, empty and clean in the dishwasher. When you have finished cooking, simply flip up the patented cook plate and turn up the controls for an amazing full Living Flame fire.



Brasiers and Flares



Outdoor entertaining at its best with the advanced designs of Living Flame gas fires creating a unique atmosphere and that special mood. Living Flame Stainless Steel Brasiers and Flares give you something different. The art of fire - creating stunning features, flames and a warm glowing feeling - bringing the romance back to today's busy lives.

Durable stainless steel gas Brasiers and Flares bring an exceptional atmosphere to special evenings. Living Flame Brasiers and Flares radiate a soft, flickering, golden glow, casting moving shadows and light around your outdoor area. Stainless steel bodies, monitored flame safety controls, a specially designed burner head and all are manufactured for either Natural Gas or LPG. Lighting which creates visual inspiration that intensifies mood, adds ambience and will enhance any outdoor area or patio.

Fire Sure Lifetime Burner Assembly Guarantee.
One Year Control Assembly Cover.
One Year Labour Cover.



Pit Fire

Outdoor 1100 - 1100 Wood Burning - Cook On



Living Flame is N.Zs. leading fire and fireplace designer with many innovations and we now bring you

The new Pit fire square Wood Burning - Cook On

A contemporary outdoor fireplace with warmth, light and atmosphere to entertain. Enjoy spring summer and autumn evenings. Designed with minimal lines to compliment our lives and homes. Cooking is such fun on the Pit fire from a tradition Kiwi Barbecue or combination of Kebabs, even Marshmallows or Camp Toast

1100 x 1100 x 400 mm high
 Heavy duty steel construction built to last
 Vented base grate for better combustion
 Easy clean stainless steel ash tray
 Wood tool and rake

Options

Stainless steel 2 mm table top cover
 Cook on plate and grill frame
 Cook on Kebab frame and skewers
 Gas Insert LPG or NG



Aura Outdoor Fireplace

Aura outdoor fireplaces let you extend your spring, summer and autumn evenings outside. No going inside as soon as it gets dark and the sun's warming rays have gone. The secret is the high levels of radiant heat generated by the Aura glowing and warming you so that you can continue entertaining friends and enjoying long summer evenings.

Aura offer you that renowned Living Flame all over glowing fire with logs, coals, embers. The innovative design and detailing allows multiple options and sizes for designers of indoor/outdoor living, landscapes, terraces, decks, pool areas and other external rooms.

Fire Sure Lifetime Body Guarantee.
 Fire Sure Lifetime Burner Assembly Guarantee.
 One Year Control Assembly Cover.
 One Year Labour Cover.



Power Flue



Power Flues and Hush Bodies are designed to be installed where a conventional open gas fireplace flue is impractical to install. The Power Flue utilises different air volumes to enable Living Flame fires to be adapted and used where normal flues and chimneys cannot. Power Flues take the place of the natural, gentle, negative draught of a conventional gas fireplace flue or chimney.



Power flues are designed to fit with the Living Flame range of electronic controlled fireplaces. Each Power Flue is fitted with safety interlocks and an operation indicator to ensure the safe operation of the whole fireplace system. Now you can still have the beauty of an open gas fire when the fireplace flue location differs from the usual.

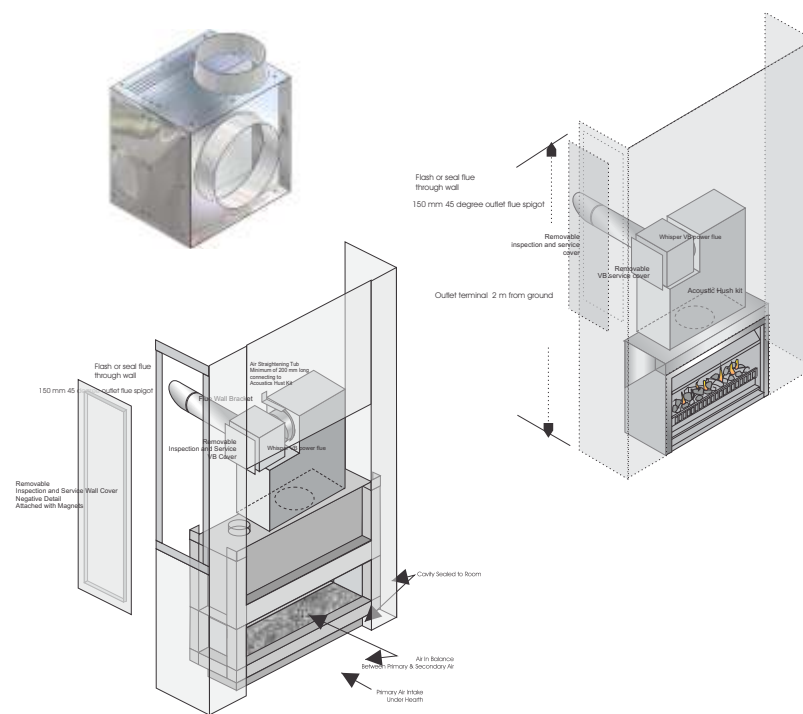

The Future - future proofing your home



Future Value
Living Flames' design background and passion, complete with the latest technology and our quality control as well as our many years of experience, give you the best fireplace. We offer an extensive after sales service, from our installation safety inspections to our routine annual services. This assures you that the fireplace you choose will enable you to enjoy your Living Flame fireplace well into the future, adding value to your life and your home.

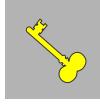

Life Cycle Costing
How much will a product cost over its' life? It's not just the purchase price. Living Flame fireplaces have the lowest gas usage when comparing size for size with other products. Living Flame also have the most comprehensive guarantees of any gas fireplace product. A Lifetime Fireplace Body Guarantee and a Lifetime Gas Burner Guarantee on all Living Flame fireplaces giving you long-term peace of mind.



Resource Friendly
Living Flame design every fireplace to be as environmentally friendly as possible, to obtain the most radiant and convected heat possible for the minimum amount of gas used. Gas is the most environmentally friendly of all the fossil fuels and will continue to play a large part in our lives well into the future.



Quality Assurance

Living Flame Fireplaces are proudly made in New Zealand to world standards for New Zealanders and others. Each fireplace is individually tested and audited to a QA Standard Schedule and signed off before they leave our testing bay.



Safety

Living Flame is at the forefront of technology in design and uses the worlds best flame monitoring devices, control and flue systems combined with safety clearances that are built into the fireplaces. For further peace of mind, Living Flame provide a free after installation safety inspection service.



Healthy Home

Living Flame Fireplaces are designed to flue all products of combustion and moisture away from the home and draw fresh air in for a healthier home. Living Flame Fireplaces also work hand in hand with Direct Air Ventilation Systems to aid in the elimination of mould and moisture.



Automation

Living Flame Systems are designed for the future with computer control automation capability, multi function remote controls and even cell phone dial give you the future control you need.



Living Flame
Auckland

Display & Head Office
343B Church St Penrose

Ph 09 6221148 Fax 6221179
Email info@livingflame.co.nz

Distributed throughout New Zealand and exported to many countries around the world